

Please read these instructions throughout before installing as incorrect fitting will invalidate the guarantee

For general information, please read 'Fixing Instructions for Shower Trays' (supplied with the tray), in conjunction with these instructions.

For information on the Walk-In Enclosure/Shower Tray
Kudos Shower Products 01539 564040

SHOWER CONTROL POSITION

Run data cable to recommended position as shown

Overall height of shower tray = 55mm

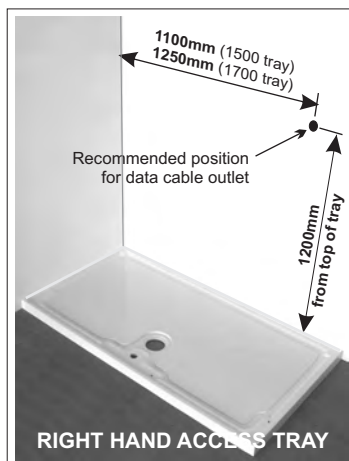
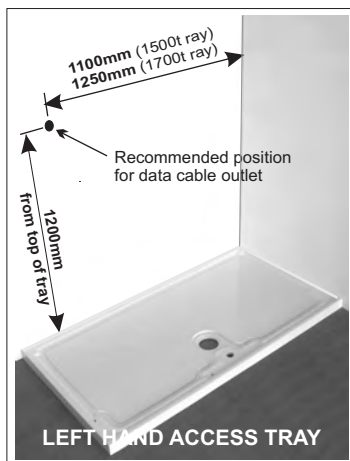

FLEXIBLE HOSE CONNECTION

THIS CONNECTION MUST BE CARRIED OUT AT THIS STAGE IF IT IS NOT POSSIBLE TO MAKE THE CONNECTION AFTER THE SHOWER TRAY HAS BEEN INSTALLED

Connect 2 metre long flexible hose to mixed water outlet on Quartz Processor unit, either:

A - Directly, if unit is within reach

B - Via 15mm copper pipe, if unit is not within reach

IMPORTANT: please take note of dimensions for exposed hose, if not adhered to, connection with the Water Outlet Body, at a later stage, will not be possible.

Ensure flexible hose is not kinked during installation process

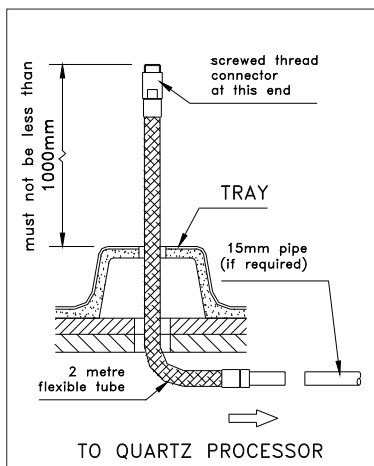

UNDER-TRAY WATER SUPPLY

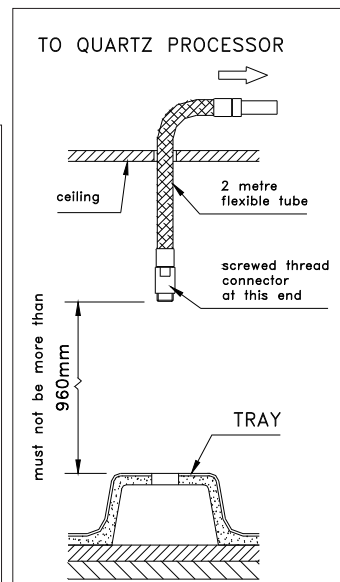

OVERHEAD WATER SUPPLY

CHECK TRAY

Ensure you have the correct tray to suit your installation

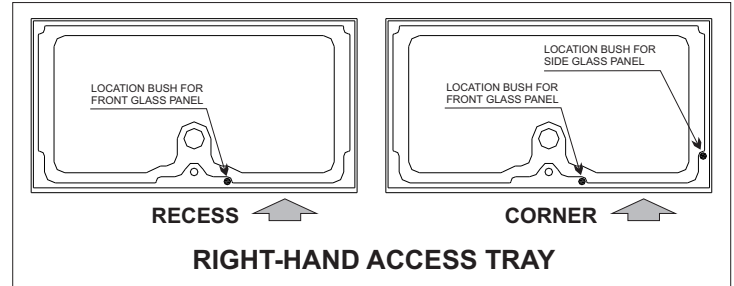
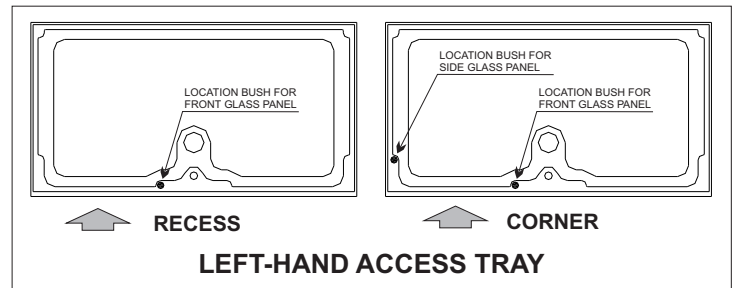

TILING ALLOWANCE

To overcome the width of the integral upstand of the shower tray, either method can be used

IMPORTANT: IF THE DIMENSIONS SHOWN ARE EXCEEDED THEN THE GLASS PANEL(S) WILL NOT FIT

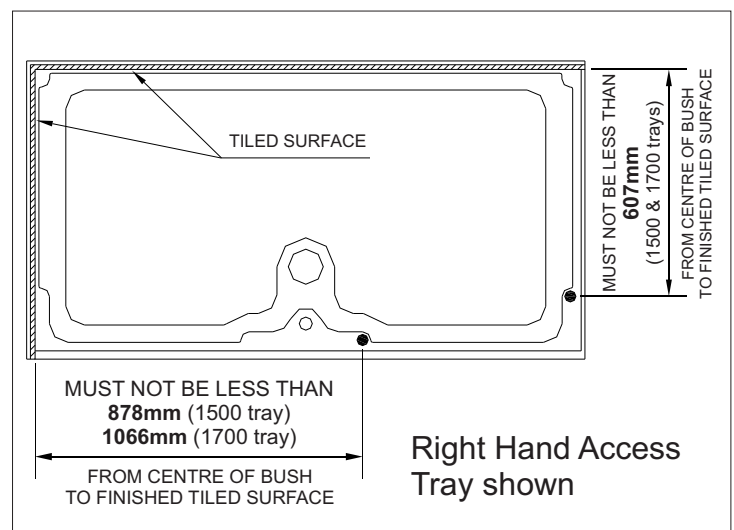
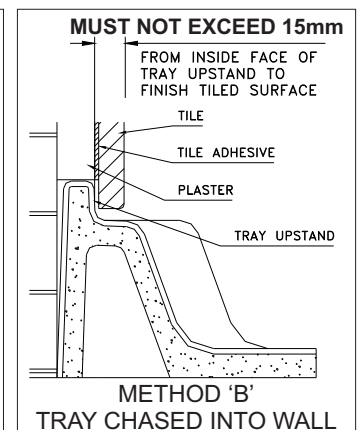
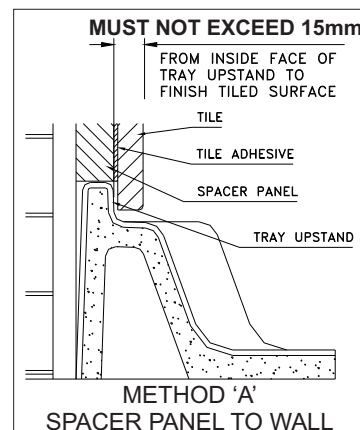

APPLY FINISH TO WALLS

Fit tiles/shower panels to the walls and apply silicone sealant where tiles/panels meet tray at bottom